

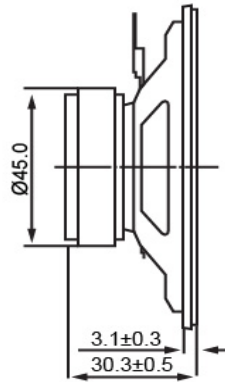

SIDE VIEW

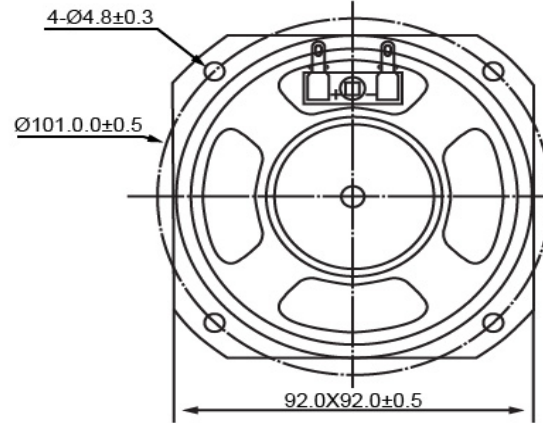

BOTTOM VIEW



Specifications			Notes	Revision History						
Description	Value	Unit		Version	Description		Date	Approved		
Shape	Rectangle		1) All dimensions are in mm unless otherwise noted 2) All parts meet RoHS	1	Released from Engineering		10/21/2013	J.S		
Resonant Frequency	200	(Hz)								
Frequency Range	200 ~ 15,000	(Hz)								
SPL @ 10cm	89	(dBA)								
Impedance	4	(Ohm)								
Cone Material	Paper									
Nominal Power	2	(W)								
Max Power	3	(W)								
Mount Type	Frame									
Operating Temperature	-25 ~ +55	°C								
Storage Temperature	-25 ~ +55	°C								
Weight	134	(g)								
 DB UNLIMITED			 Dynamic Speaker			SP920204-1				

Additional considerations can be found at www.dbunlimitedco.com/technical-articles.