

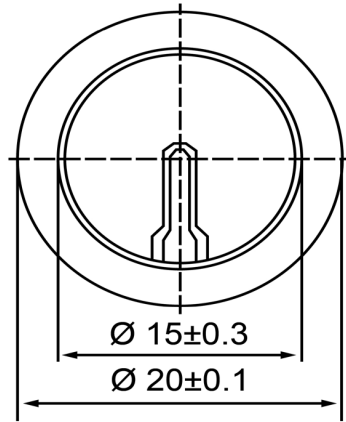

TOP VIEW

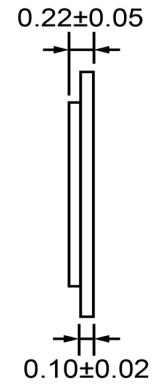

SIDE VIEW



Specifications			Notes	Revision History					
Description	Value	Unit		Version	Description	Date	Approved		
Resonant Frequency	3,900	(Hz)	1) All dimensions are in mm unless otherwise noted 2) All parts meet RoHS	1	Released from Engineering	10/21/2013	J.S		
Resonant Impedance (Max)	400	(Ohm)							
Max Input Voltage	30	(V)							
Capacitance	25,000	(pF)							
Plate Material	Brass								
Operating Temperature	-20 ~ +60	°C							
Storage Temperature	-30 ~ +70	°C							
			 DB UNLIMITED	Drawn by	Date	Checked by	Date	Approved by	Date
				A.B.	10/21/2013	C.E.	10/21/2013	J.S	10/21/2013
				Piezo Bender			P20039-1		

Additional considerations can be found at www.dbunlimitedco.com/technical-articles.